

Simpson panel instruments...

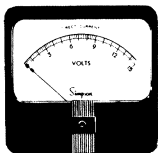

900 STOCK TYPES

... plus HUNDREDS MORE, custom-built
from standing tools ✱

INSTRUMENTS THAT STAY ACCURATE

✱ Send us your special meter requirements today. Let our top-flight engineers work out solutions or make recommendations best suited to your needs.

YOUR ELECTRONIC PARTS DISTRIBUTOR
HAS HUNDREDS IN STOCK!

Simpson ELECTRIC COMPANY

5200 West Kinzie St., Chicago 44, Ill. Phone: Estebrook 9-1121
In Canada: Bach-Simpson, Ltd., London, Ontario



2 1/2" RECTANGULAR
ACCURACY: ± 2%
SCALE LENGTH: 1 7/8"

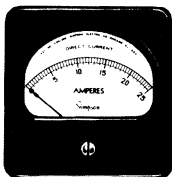

3 1/2" RECTANGULAR
ACCURACY: ± 2%
SCALE LENGTH: 2-9/16"



2 1/2", 3 1/2", 4 1/2"
WIDE VUE
ACCURACY: ± 3%

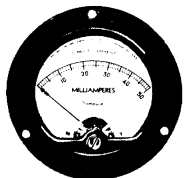

2 1/2" or 3 1/2" ROUND
ACCURACY: ± 2%
SCALE LENGTH: 1 7/8"



EDGEWISE
ACCURACY: DC ± 2%
SCALE LENGTH: 1 7/8"



ELAPSED TIME
INDICATOR
110/220 VOLTS

OPERATOR'S MANUAL

VOLT-OHM-MILLIAMMETER MODEL 230

Courtesy of Simpson260.com

& Instrument Meter Specialties - MeterSales.com

SIMPSON ELECTRIC COMPANY

5200 W. Kinzie St., Chicago 44, Illinois, Estebrook 9-1121

In Canada, Bach-Simpson, Ltd., London, Ontario

SIMPSON ELECTRIC COMPANY • CHICAGO 44, ILLINOIS

Copyright 1956, Simpson Electric Co.,

Printed in U.S.A.

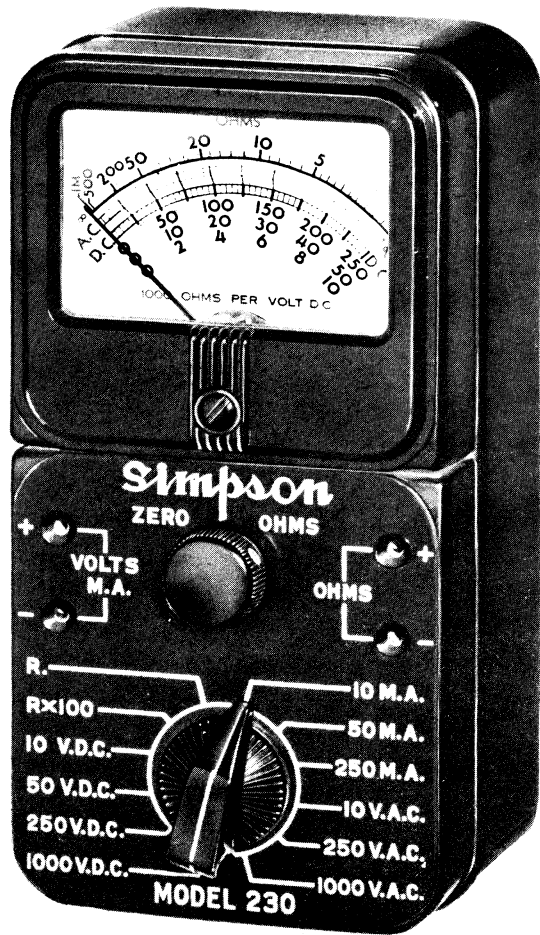

FIGURE 1. SIMPSON VOLT-OHM-MILLIAMMETER
MODEL 230

SECTION I

GENERAL DESCRIPTION

The Simpson Volt-Ohm-Milliammeter Model 230, shown in figure 1, is a handy and compact combination servicing instrument which has been designed for use in servicing radio receivers. It is also useful for many other electrical and electronic applications.

It has convenient ranges for measuring D.C. voltages, direct currents, resistances, and A.C. voltages. All the ranges and circuit arrangements are made easily and quickly with the range switch at the bottom of the front panel. The test leads connect into circuit jacks on the front panel, and are used to contact the source of electrical characteristics for measurements.

SIZE

The Model 230 is very compact, measuring only 3-1/16" wide by 5-7/8" long by 2-5/8" deep. It is designed for both convenience and safety.

General Description

TEST LEADS

The pair of test leads, one red and one black for polarity identification, are approximately four feet long. These test leads are furnished with crocodile clip terminations.

Either clip the leads to the test points in the circuit which is being measured, or hold the ends on the test points for momentary contacts.

INSULATED CLIPS

Flexible plastic insulators over the crocodile clips protect the operator from contacting any voltage present on the clips.

METER MOVEMENT

The meter movement is one of the famous Simpson INSTRUMENTS THAT STAY ACCURATE. It has a sensitivity of 1 milliamperes D.C., with an internal resistance of 100 ohms. The special 2-1/2" dial is calibrated for all the measuring circuits and ranges of the Model 230.

HANDLE CAREFULLY

The meter is very rugged and will withstand

General Description

considerable use without showing any signs of damage. However, the parts are made to fit together with the precision of a fine watch, and they can be damaged by careless handling.

Be careful to prevent your Model 230 from being dropped, and from any other unnecessary shocks. If you treat your instrument with care, it will reward you with many years of trouble-free service and accurate indications of measured values.

RANGE SWITCH

There are two control knobs on the front panel. The large one at the bottom is the range switch. It has twelve positions, each marked for the circuit and the range which it will set up in the instrument.

ZERO OHMS

The small knob above the range switch is the ZERO OHMS control knob. It operates a continuously variable resistor which will compensate for aging of the internal battery when you are using resistance measuring circuits.

General Description

TEST LEAD CONNECTIONS

There are two pairs of contacts into which you will connect the test leads. On the left hand side is the pair which you will use for measuring voltage or current with the Model 230. On the right hand side is the pair of contacts which you will use when measuring resistances.

INTERNAL CONSTRUCTION

Inside the lower half of the instrument case are all the resistors, the rectifier, and the battery, which make up the circuits for the various ranges.

This half of the instrument can be taken out of the case for trouble-shooting, repair, and battery replacement when it is necessary.

HOW TO OPEN INSTRUMENT

Remove the four screws through the back of the case and pull the lower half of the instrument toward the bottom and out of the case. All the components will come out with the front panel.

There are two wire leads which connect

General Description

these circuit portions to the indicating meter; when you remove the lower portion of the instrument from the case, be careful to prevent damage to the leads.

REPAIRING THE METER

Since all repair to the meter portion of the Model 230 should be performed only by qualified repairmen with the proper tools, the top half of the instrument is sealed. Do not attempt to remove it from the case.

If any repair is necessary, return the entire Model 230 to the Repair Department at the factory, or to your nearest Official Simpson Repair Station.

Whenever you return an instrument to a repair station or to the factory, be sure to write a letter to explain exactly what you think is wrong with it and why. This will save both time and money for you.

Also indicate in the letter what you want the repair station or factory to do, so they have the necessary authorization from you to proceed with your repairs.

General Description

RANGES

D.C. VOLTAGE

1000 ohms per volt sensitivity

- 0-10 volts
- 0-50 volts
- 0-250 volts
- 0-1000 volts

A.C. VOLTAGE (RMS VALUES)

400 ohms per volt sensitivity

- 0-10 volts
- 0-250 volts
- 0-1000 volts

D.C. RESISTANCE

- 0-1000 ohms (12 ohms center)
- 0-100,000 ohms (1200 ohms center)

D.C. CURRENT

- 0-10 milliamperes
- 0-50 milliamperes
- 0-250 milliamperes

SECTION II

OPERATION

CAUTION

When you are measuring voltage, as a personal protection, form the habit of turning off all power to the circuit under test. Connect the test leads at the desired points in the circuit. Then turn on the power while taking readings. Turn off the power before disconnecting the test leads from the circuit.

ADJUST POINTER FOR ZERO

Before any measurements are made with your Volt-Ohm-Milliammeter Model 230, check to see that its pointer indicates zero with the instrument in its operating position. If the pointer is off zero, adjust the screw located in the bakelite case just below the center of the dial.

Use a small screwdriver to turn this screw slowly either clockwise or counterclockwise until the pointer rests over the zero mark on the dial.

Operation

D.C. VOLTAGE MEASUREMENTS

1. Set the range switch at the bottom of the front panel for the D.C. voltage range desired. These positions are marked 10 V.D.C., 50 V.D.C., 250 V.D.C., and 1000 V.D.C. When in doubt as to the voltage present, always use the highest range as a protection to the instrument. Observe the meter reading. If the voltage is within a lower range, set the range switch for the lower range to obtain a more accurate reading.
2. Plug the black test lead into the jack marked -VOLTS M.A. on the left hand side of the front panel. Plug the red test lead into the jack marked +VOLTS M.A.
3. Connect the crocodile clip end of the black test lead to the negative side of the circuit to be measured, and the crocodile clip end of the red test lead to the positive side of the circuit.
4. Turn on the power in the circuit which is to be measured. If the pointer of the meter deflects to the left, the leads are reversed with respect to circuit polarity. Turn off the power, reverse the test lead

Operation

connections, and then turn on the power again.

5. Read the voltage on the black arc marked D.C.
For the 10 V.D.C., 50 V.D.C., and 250 V.D.C. ranges, read the voltage directly on the black arc.
For the 1000 V.D.C. range, read the 0 to 10 scale on the black arc and multiply the reading by 100.
6. Turn off the power before you disconnect the test leads.

A.C. VOLTAGE MEASUREMENTS

1. Set the range switch at the bottom of the front panel for the A.C. voltage range desired. These marked 10 V.A.C., 250 V.A.C., and 1000 V.A.C. When in doubt as to the voltage present, always use the highest voltage range as a protection to the instrument.
2. Plug the black test lead into the jack marked -VOLTS M.A. on the left hand side of the front panel. Plug the red test lead into the jack marked +VOLTS M.A.
3. Connect the crocodile clips for the two

Operation

test leads to the two sides of the circuit to be measured. Connect one clip to each side of the circuit. For A.C. voltage measurements, readings will be the same with either polarity of lead connections.

4. Turn on the power in the circuit to be measured.
5. Read the voltage on the red arc marked A.C.

For the 10 V.A.C. and 250 V.A.C. ranges, read the voltages directly on the red arc.

For the 1000 V.A.C. range, read the 0 to 10 scale on the red arc and multiply the reading by 100.

6. Turn off the power before you disconnect the test leads.

D.C. RESISTANCE MEASUREMENTS

CAUTION

Before you make any resistance measurements in an electrical circuit, be sure the power is off and all capacitors have been discharged, so no voltage exists in the circuit. Otherwise

Operation

you may damage the meter circuits.

1. Set the range selector switch at the bottom of the front panel for the range desired for resistance measurement. These switch positions are marked R and Rx100.
2. Plug the black test lead into the jack marked -OHMS on the right hand side of the front panel. Plug the red test lead into the +OHMS jack.
3. Short the crocodile clips together. Rotate the ZERO OHMS knob until the pointer indicates 0 at the right hand end of the dial. If the pointer will not move to the 0 mark, the battery is weak and needs to be replaced. See instructions in Section III, MAINTENANCE.
4. Separate the test leads and connect them across the resistance or the portion of a circuit which is to be measured. The more accurate reading is obtained on the range which indicates nearer the center of the scale.
5. Read the value indicated on the black arc at the top of the dial, marked OHMS. Note

Operation

that this scale increases from right to left.

For the R. range, read the resistance directly on the OHMS arc. (M=1000).

For the R x 100 range, read the indication on the OHMS arc and multiply the reading by 100.

See instructions in Section IV for measuring resistances over 100,000 ohms.

DIRECT CURRENT MEASUREMENTS

CAUTION

Never connect the test leads directly across any voltage with the Model 230 set for current measurements. This would damage the instrument. Always connect the meter in series with the load across the voltage source.

1. Set the range switch for the current range desired. These switch positions are marked 10 M.A., 50 M.A., and 250 M.A. When in doubt as to the current present, always use the highest current range as a protection to the instrument.
2. Plug the black test lead into the jack marked -VOLTS M.A. on the left hand

Operation

side of the front panel. Plug the red test lead into the jack marked +VOLTS M.A.

3. Open the circuit in which current is to be measured. Connect the Model 230 in series with the circuit. Connect the red test lead toward the positive side of the circuit and the black test lead toward the negative side.
4. Turn on the power in the circuit to be measured. If the pointer of the meter is deflected to the left, the leads are reversed with respect to circuit polarity. Turn off the power, reverse the test leads, and turn on the power again.
5. Read the current values in milliamperes on the black arc of the meter marked D.C. Use the 0 to 10 figures for the 10 M.A. range, the 0 to 50 figures for the 50 M.A. range, or the 0 to 250 figures for the 250 M.A. range.
6. Turn off the power before disconnecting the test leads.
7. Restore the circuit continuity.

Operation

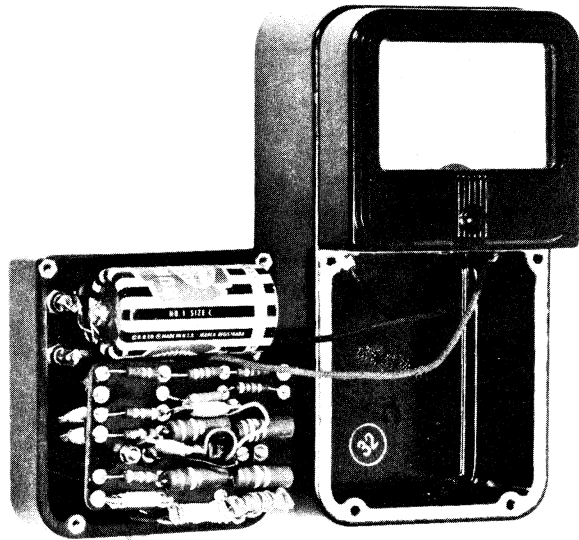

FIGURE 2. MODEL 230 WITH CASE OPENED
TO SHOW INTERNAL COMPONENTS

SECTION III MAINTENANCE

PLACEMENT OF COMPONENT PARTS

All the component parts of the circuits in the Volt-Ohm-Milliammeter Model 230 except the meter are available when you remove the lower half of the instrument from its case as shown in figure 2.

Remove the four mounting screws through the case back and then pull the lower half of the instrument out of the case. Be careful to prevent damage to the two meter leads which are attached to the lower half of the instrument.

Resistors R5, R6, and R12 are attached to terminals on the two decks of the range switch. All the other resistors are laid on a terminal board on the back of the range switch. They are attached with their wire leads. The rectifier is also attached to this terminal board. The arrangement of parts is shown in figure 3.

On the terminal board, resistors R7, R8, R9, and the series and shunt resistors for the

Maintenance

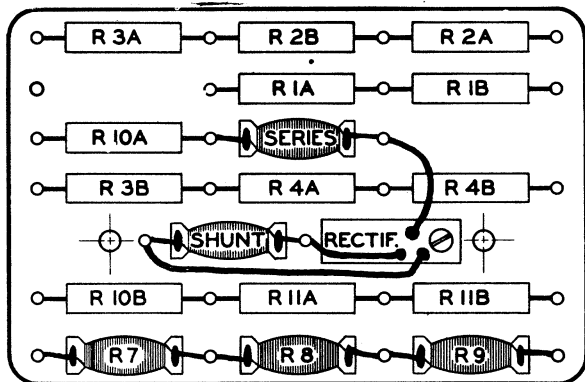

NOTE: ALL CARBON RESISTORS ARE SERIES MATCHED PAIRS. FOR EXAMPLE R 1A AND R 1B TOGETHER MAKE THE RESISTANCE SHOWN AS R 1 IN THE SCHEMATIC.

FIGURE 3. LOCATION OF PARTS ON TERMINAL BOARD

rectifier are all bobbin type wire wound resistors. If the series or shunt resistor needs to be replaced, or if you have any trouble with the rectifier, all three of these items must be replaced as a unit. The rectifier has its own forward and reverse resistance, and the series and shunt resistors are matched to the rectifier characteristics.

BATTERY REPLACEMENT

The 1.5 volt dry cell inside the case of the

Maintenance

Model 230 is used for resistance measurements. It is shown in figure 2, and is attached to the inside of the case with wire leads which are soldered to the battery terminals. During its normal use-life, the battery will gradually increase its internal resistance. This will result in a decrease of terminal voltage under normal load.

When the pointer can no longer be brought to 0 on the OHMS arc with the ZERO OHMS knob, replace the battery with a new one.

Remove the lower half of the instrument from the case as described above. Unsolder the leads from the case of the old battery and remove it from the instrument. Place a new #1, size C, 1.5 volt cell in the same position in the instrument, with its positive post nearest the contact jack marked +OHMS. Solder the wire from this contact jack to the positive battery terminal. Then solder the wire from the center terminal of the ZERO OHMS control, R13, to the bottom of the battery case, for negative polarity.

Maintenance

Maintenance

PARTS LIST

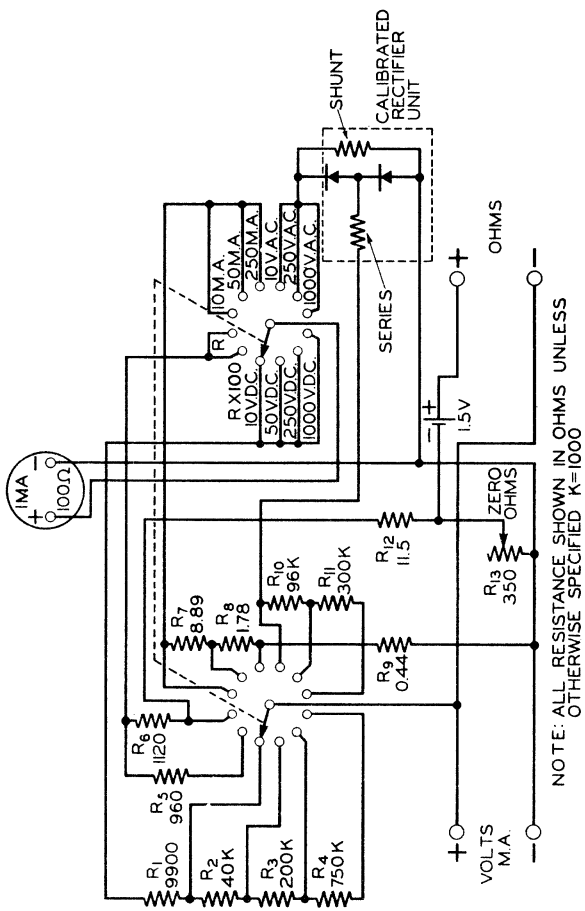

FIGURE 4. VOLT-OHM-MILLIAMMETER
MODEL 230, OVERALL SCHEMATIC DIAGRAM

Reference Symbol	Description	Simpson Part No.
R1	Resistor, 9900 ohms, 2%	1-112753
R2	Resistor, 40,000 ohms, 2%	1-111584
R3	Resistor, 200,000 ohms, 2%	1-111596
R4	Resistor, 750,000 ohms, 2%	1-111595
R5	Resistor, 960 ohms, wire wound bobbin	0-008105
R6	Resistor, 1120 ohms, wire wound bobbin	0-008107
R7	Resistor, 8.89 ohms, wire wound bobbin	0-008067
R8	Resistor, 1.78 ohm, wire wound bobbin	0-008058
R9	Resistor, 0.44 ohm, wire wound bobbin	0-008052
R10	Resistor, 96,000 ohms, 2%	1-112752
R11	Resistor, 300,000 ohms, 2%	1-112751
R12	Resistor, 11.5 ohms, wire wound bobbin	0-008071
R13	Potentiometer, 350 ohms, for ZERO OHMS	1-112749
	Battery (Eveready or Burgess No. 1 Cell)	1-111801

Maintenance

Knob for ZERO OHMS	1-111756
Knob for range switch	3-262871
Rectifier assembly (with series & shunt resistors)	0-008582
Test leads, pair	0-008375

SECTION IV

RANGE EXTENSIONS

MEASURING HIGH VOLTAGE D.C.

Occasionally there may be some voltage greater than 1000 volts D.C. which you will have to measure. When this is true, you can increase the range of your Model 230 by adding an external series multiplier resistor as shown in figure 5. Use the following steps.

1. Set the range switch at 1000 V.D.C. and connect the test leads in the VOLTS M.A. jacks at the left hand side of the instrument. Connect the red test lead in the + jack and the black test lead in the - jack.
2. Connect the crocodile clip for the red test lead to one terminal of the multiplier

Range Extensions

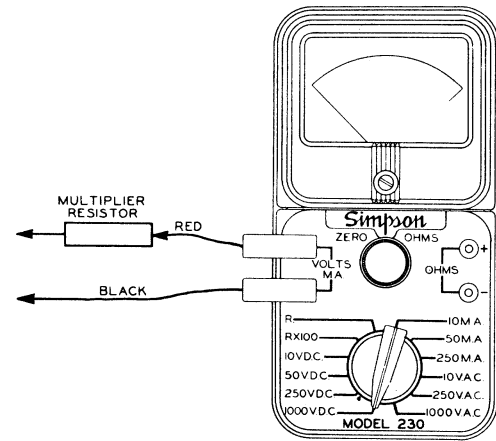

FIGURE 5. INCREASING VOLTAGE RANGES

3. Use the other terminal of the multiplier resistance as the positive probe, and the black test lead as the negative probe. Connect these into the circuit where you wish to measure voltage, while the power is off.

Range Extensions

CAUTION

Never touch the meter, leads, or any other parts of the measuring circuit while power is on for high voltage measurements. Connect and disconnect the leads while power is off and there is no voltage in the circuits.

4. Observe the reading on the meter as for lower D.C. voltage measurements.
5. Turn off the power before you disconnect the probes from the circuit in which you measured the voltage.

MEASURING HIGH RESISTANCE

With the aid of a circuit such as shown in figure 10, you can measure resistance values up to 1 megohm. Set the range switch at its Rx100 position. The range which you will set up with the circuit will be Rx1000, so multiply the reading which you get on the OHMS scale of the dial by 1000 (add three zeros).

Use whatever combination you may have available to make up 13.5 volts, which is 9 cells in series. One combination would be

Range Extensions

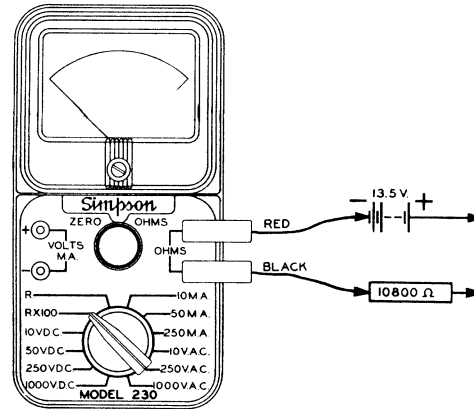

FIGURE 6. INCREASING RESISTANCE RANGES

three 4.5 volt C batteries in series. Another would be two 6 volt batteries and one 1.5 volt cell in series. Still another way to get it is to use two "C" batteries with five cells each, which have taps at each 1.5 volts; use the entire 7.5 volts from one battery and four cells (6 volts) from the second, all connected in series.

For the resistance, which is indicated as 10,800 ohms, any value close to that amount

Range Extensions

will provide satisfactory indications with your ohmmeter. The closer you can get to that exact value, the more accurate your values will be. But accuracy is not usually necessary for resistance readings.

Remember that the resistance does not have to be a single resistor, but can be any combination which will produce a series equivalent resistance of 10,800 ohms.

MIDGETESTER Model 355

**AC-DC VOLT-OHMETER
SELF SHIELDED!**

Fits in Your Shirt Pocket!

\$34⁹⁵

Leather Zipper
Case \$2.95

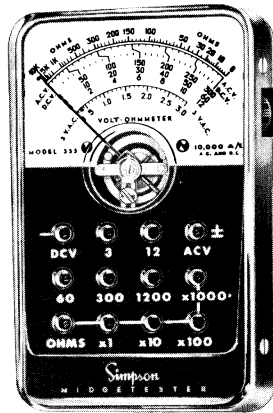

MODEL 262

Deluxe!

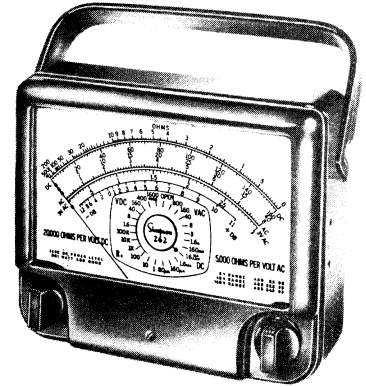
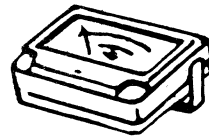

the new VOM with a 7" meter

20,000 Ohms per volt DC and 5,000
Ohms per volt AC sensitivity . . . 33
ranges . . . compact

7" case with Adjust-

A-Vue Handle **\$59.50**

Carrying Case **\$ 9.95**

MODEL 269

**100,000
Ohms
per volt!**

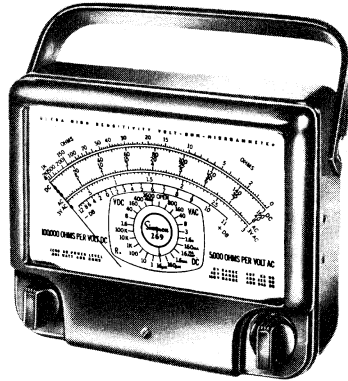
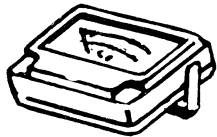

**Most sensitive VOM
available!** A Volt-Ohm-Microam-
meter with a big 7" meter in a com-
pact 7" case... 33 ranges... Adjust-
A-Vue Handle ... **\$88.00**
price complete.....
Carrying Case **\$ 9.95**

WARRANTY

SIMPSON ELECTRIC COMPANY warrants each instrument and other articles of equipment manufactured by it to be free from defects in material and workmanship under normal use and service, its obligation under this warranty being limited to making good at its factory any instrument or other article of equipment which shall within 90 days after delivery of such instrument or other article of equipment to the original purchaser be returned intact to it, or to one of its authorized service stations, with transportation charges prepaid, and which its examination shall disclose to its satisfaction to have been thus defective; this warranty being expressly in lieu of all other warranties expressed or implied and of all other obligations or liabilities on its part, and SIMPSON ELECTRIC COMPANY neither assumes nor authorizes any other persons to assume for it any other liability in connection with the sale of its products.

This warranty shall not apply to any instrument or other article of equipment which shall have been repaired or altered outside the SIMPSON ELECTRIC COMPANY factory or authorized service stations, nor which has been subject to misuse, negligence or accident, incorrect wiring by others, or installation or use not in accord with instructions furnished by the manufacturer.

Simpson ELECTRIC COMPANY
5200 Kinzie St., Chicago 44, Illinois • Phone: EStebrook 9-1121

In Canada: Bach-Simpson, Ltd., London, Ontario



LAC DU FLAMBEAU PLANT
WISCONSIN



LAKE STREET PLANT
CHICAGO



KINZIE STREET PLANT
CHICAGO



AURORA PLANT
AURORA, ILL.