

# Simpson panel instruments...

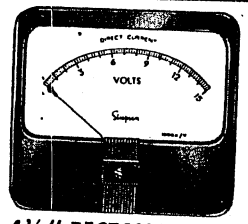

4 1/2" RECTANGULAR

**1375 STOCK TYPES**  
 ... plus HUNDREDS MORE, custom-built  
 from standing tools ✖  
**INSTRUMENTS THAT STAY ACCURATE**

\* Send us your special meter requirements today. Let our top-flight engineers work out solutions or make recommendations best suited to your needs.

**Simpson ELECTRIC COMPANY**

5200 West Kinzie St., Chicago 44, Ill. Phone: ESlebrook 9-1121  
 In Canada: Bach-Simpson, Ltd., London, Ontario

YOUR ELECTRONIC PARTS DISTRIBUTOR  
 HAS HUNDREDS IN STOCK!

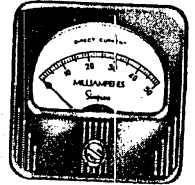

2 1/2" RECTANGULAR  
 ACCURACY: ±2%

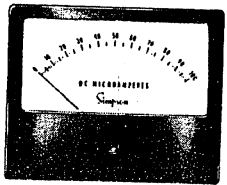

6" RECTANGULAR  
 ACCURACY: ±2%

See the Simpson  
**ADD-A-TESTER ADAPTERS**  
 they will increase the  
 versatility of your  
 260 or 270 VOM'S.

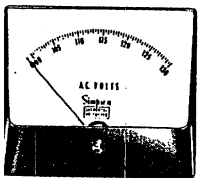

" , 2 1/2" , 3 1/2" , 4 1/2"  
**WIDE VUE**  
 ACCURACY: ±2%

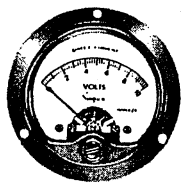

2 1/2" or 3 1/2" ROUND  
 ACCURACY: ±2%

- TRANSISTOR TESTER  
 Model 650 .....\$29.95
- DC VTVM  
 Model 651 .....\$39.95
- TEMPERATURE TESTER  
 Model 652 .....\$39.95
- AC AMMETER  
 Model 653 .....\$19.95
- AUDIO WATTMETER  
 Model 654 .....\$19.95
- MICROVOLT ATTENUATOR  
 Model 655 .....\$19.95
- BATTERY TESTER  
 Model 656 .....\$19.95
- MILLIOHMMETER  
 Model 657 .....\$44.95
- DC AMMETER  
 Model 661 .....\$19.95

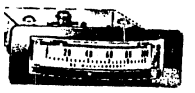

**EDGEWISE**  
 ACCURACY: DC ±2%  
 SCALE LENGTH: 1 1/8"

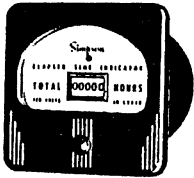

**ELAPSED TIME INDICATOR**  
 110/220 VOLTS

## OPERATOR'S MANUAL

### VOLT-OHM-MILLIAMMETER 270 SERIES 3

Courtesy of:  
[Simpson260.com](http://Simpson260.com)  
 With Thanks to: Jerry Brown

#### SIMPSON ELECTRIC COMPANY

5200 W. Kinzie St., Chicago, Illinois 60644  
 Area Code 312, Telephone 379-1121  
 In Canada, Bach-Simpson, Ltd., London, Ontario

Copyright 1966-Simpson Electric Co.  
 2-66 JMO B & L

Printed in U.S.A.  
 5-110338

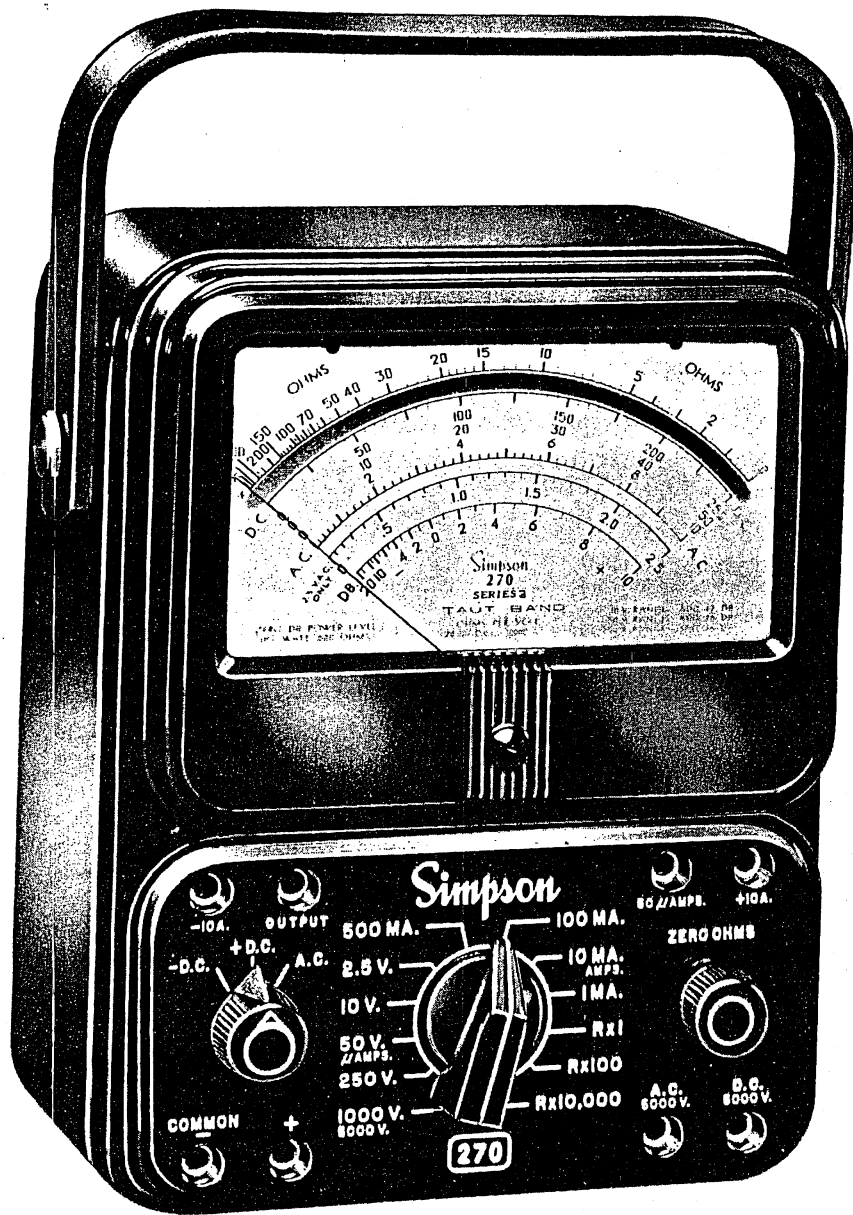

FIG. 1. SIMPSON VOLT-OHM-MILLIAMMETER, 270 SERIES 3.

## SECTION I

### GENERAL DESCRIPTION

The 270 Series 3 is a rugged, accurate, compact, easy to operate instrument. It is used to measure electrical characteristics of circuits and circuit components. It indicates quantity measurements for D.C. and A.C. voltages, D.C. currents, resistances, decibels and output voltages. To complement the circuit accuracy, this tester features the new Simpson taut-band, annular movement. The annular movement provides self-shielding, and the taut-band suspension provides a high degree of repeatability that is greatly resistant to damage by shock or vibration. Thus, you can be confident that the instrument you have just purchased will remain accurate for many years of service.

The 270 Series 3 also incorporates a special calibration circuit for increased accuracy. Should the unit get out of adjustment it facilitates its return to the original factory accuracy.

This instrument, owing to its predictable temperature response all on ranges and use of gold bonded germanium diodes on the A.C. ranges, provides high precision and stability over a wide temperature range.

The 270 Series 3 has been designed to utilize the most modern components and circuit techniques. It is manufactured by skilled workmen using high quality materials and in modern plants using the best machines, tools and test equipment available. It will, therefore, take considerable

## General Description

abuse and still continue to function. However, it does contain a very precise instrument movement and therefore, we urge that you treat it with the care it deserves. If you will keep it clean, free from continuous severe vibration, avoid dropping it and subjecting it to high electrical overloads, it will give you many years of trouble-free dependable service.

## PHYSICAL

### FRONT PANEL

The instrument has a large easy-to-read  $4\frac{1}{2}$ " meter at the top of the front panel. Below the meter are three operating controls and eight circuit jacks. All switch positions and circuit jacks are deeply engraved with white lettering on black phenolic to insure long time readability.

### RANGE SWITCH

The range switch, in the center of the lower part of the front panel, has 12 positions. It may be turned in either direction to obtain any desired range and circuit position. There are six voltage ranges for D.C. and six for A.C., six ranges for direct current, and three resistance ranges.

### FUNCTION SWITCH

The function switch is located at the left hand side of the lower part of the front panel. It has three positions: -D.C., +D.C., and A.C. When direct current, D.C. voltage, or resistance is to be measured, the function switch may be set at -D.C. or +D.C., depending on the polarity of current

## General Description

or voltage. Reversing the test lead connections without removing them from the circuit under test is accomplished by using the function switch.

### ZERO OHMS

The control at the lower right on the panel is marked ZERO OHMS. This variable resistance in the ohmmeter circuit is used to compensate for the aging of the internal batteries.

### CIRCUIT JACKS

There are eight jacks, two in each corner of the front panel. These are the connection points for the test leads. Plug the prods of the test leads into the proper jacks to obtain the circuit and range desired for each application.

At the lower left are COMMON - and + jacks. These are the jacks that will be used most. Connect the black test lead to COMMON - for all circuits and ranges except 10 amperes D.C. Connect the red test lead to the + jack for all circuits and ranges except those designated by the other circuit jacks.

Across the top of the panel are jacks marked -10 A., OUTPUT,  $50\mu\text{AMPS}$ , and +10 A. For all audio frequency output voltage ranges, use the red test lead connected to the OUTPUT jack. For the 50 microampere or 250 millivolt D.C. range, use the red test lead connected to the  $50\mu\text{AMPS}$  jack. For the 10 ampere D.C. range, use the black test lead in the -10A. jack and the red test lead in the +10 A. jack.

## General Description

### PRINTED CIRCUIT

Conforming to the latest engineering developments, most of the component parts are mounted on a printed circuit. This simplifies assembly, reduces maintenance, and extends the useful life of the instrument.

### PHENOLIC CASE

The phenolic case, designed and molded with heavy reinforced walls for greatest durability, provides maximum protection for the circuit components it houses.

### ADJUST-A-VUE HANDLE

The comfortable handle is attached on each side of the instrument case. The handle may be used to support the instrument in a convenient, sloping position for easy viewing on the bench top. Of course, it can also be placed in either a vertical or horizontal position.

### TEST LEADS

Each instrument is furnished with one pair of four-foot test leads. One lead is black and the other red for easy polarity identification.

The wire is very finely stranded and extra-flexible. Its insulation is a special high-grade rubber which has far more insulation strength than the highest voltages to which your instrument should ever be subjected.

### TEST LEAD INSPECTION

Periodic inspection of the test leads is recommended to

## General Description

detect cuts, burns or other damage that could reduce the insulation strength of the leads. When replacement is indicated, ask your local distributor for catalog number 7500.

### OVERLOAD PROTECTION

To minimize the possibility of accidental damage due to overloads, specially produced diodes protect the movement from burn-out or mechanical damage (such as bent pointer) even with 1000 times the normal current applied.

In addition, a fuse is provided to help protect the circuitry from damage due to overloads. This protective combination will prevent serious damage in most cases of accidental misuse. However, no overload protection system is completely foolproof, and misapplication on high voltage circuits can damage any VOM, protected or not. Care and caution should always be exercised to protect both you and your instrument.

### SIZE AND WEIGHT

The 270 measures 5 $\frac{1}{4}$ " x 7" x 3-1/8". It weighs 3 pounds.

## ELECTRICAL

### MEASUREMENT RANGES

D.C. VOLTAGE	ACCURACY	ACCURACY
	AT 77°F	67-87°F
Sensitivity; 20,000 ohms-per-volt		
0- 250 millivolts	1.25%	1.75%
0- 2.5 volts	1.25%	1.75%
0- 10 volts	1.25%	1.75%

## ELECTRICAL

### MEASUREMENT RANGES

0- 50 volts	1.25%	1.75%
0- 250 volts	1.25%	1.75%
0-1000 volts	1.25%	1.75%
0-5000 volts	2.25%	2.75%

### A.C. VOLTAGE

Sensitivity; 5,000 ohms-per-volt

	ACCURACY AT 77°F	ACCURACY 67-87°F
0- 2.5 volts	2.0%	3.0%
0- 10 volts	2.0%	3.0%
0- 50 volts	2.0%	3.0%
0- 250 volts	2.0%	3.0%
0-1000 volts	2.0%	3.0%

### DIRECT CURRENT

	ACCURACY AT 77°F	ACCURACY 67-87°F
0- 50 microamperes	.75%	1.25%
0- 1 milliamperes	1.25%	1.75%
0- 10 milliamperes	1.25%	1.75%
0- 100 milliamperes	1.25%	1.75%
0-500 milliamperes	1.25%	1.75%
0- 10 amperes	1.25%	1.75%

### D.C. RESISTANCE

	ACCURACY AT 77°F	ACCURACY 67-87°F
R x 1 for 0-2000 ohms (12 ohms center)	1.5° of arc	1.75° of arc
R x 100 for 0-2000,000 ohms (1200 ohms center)	1.0° of arc	1.25° of arc
R x 10,000 for 0-20 megohms (120,000 ohms center)	1.0° of arc	1.25° of arc

## ELECTRICAL

### MEASUREMENT RANGES

#### A.F. OUTPUT VOLTAGE

With 0.1 $\mu$ f internal series capacitor

0- 2.5 volts
0- 10 volts
0- 50 volts
0-250 volts

#### VOLUME LEVEL IN DECIBELS

With zero DB equal to 1 milliwatt across a 600 ohm line

-20 to +10 DB
- 8 to +22 DB
+ 6 to +36 DB
+20 to +50 DB

Accuracies are specified for use with the 270, Series 3 in a horizontal plane.

In summary, the change in accuracy with a 10° Fahrenheit temperature change from 77°F. is  $\pm\frac{1}{2}\%$  on DC and  $\pm 1\%$  on AC. These accuracy changes are linear over this temperature range, being  $\pm 0.05\%$  per °F. on DC and  $\pm 0.1\%$  per °F. on AC.

In order to apply the temperature correction factors indicated above, the temperature of the electrical elements of the instrument must be known. It can be assumed that this temperature is that of the area in which the instrument is being used if it has been in this area (or another area of very nearly equal temperature) for a period of at least four hours. This time lapse can be materially reduced by the

## General Description

removal of the case and providing rapid air flow around the electrical elements.

The 270 has a 100 degree dial with the D.C. scale divided into equal intervals of 2 degrees each. The accuracies stated as " $\pm x$  % of full scale value" can be directly visualized as " $\pm \frac{x}{2}$  divisions of DC scale." For example, " $\pm 2\%$  of FS" is equivalent to saying " $\pm 1$  division of DC scale." This is an exact method when measuring DC and close enough for practical purposes on the ohms, AC, and db scales.

## INTERNAL BATTERIES

There are five 1.5 volt batteries inside the instrument. These are used for the ohmmeter circuits. One large cell is used to furnish 1.5 volts for the R x 1 and R x 100 ranges. Four smaller cells are added in series to furnish 7.5 volts for the R x 10,000 range.

Each battery is held in place with two special spring clips which also serve as battery contacts. The polarity symbols are marked on the panel. Always observe polarity when replacing batteries.

## FREQUENCY RESPONSE

The frequency response for A.C. voltage measurements is essentially "flat" through the range from 20 cycles per second up to 100,000 cycles per second.

## Operating Instructions

### TRANSPORT

It is advisable to shunt the meter movement during transport. This is readily achieved by setting the function switch at D.C. and the range switch at 500MA.

## SECTION II

### OPERATING INSTRUCTIONS

#### CAUTION

Connecting test leads to an energized circuit can present personal and/or equipment hazards. Turn off power before attaching or removing test leads in or adjacent to high voltage circuits. This procedure applies particularly to a current measurement in an inductive circuit due to the presence of higher than normal voltages if the current circuit is opened.

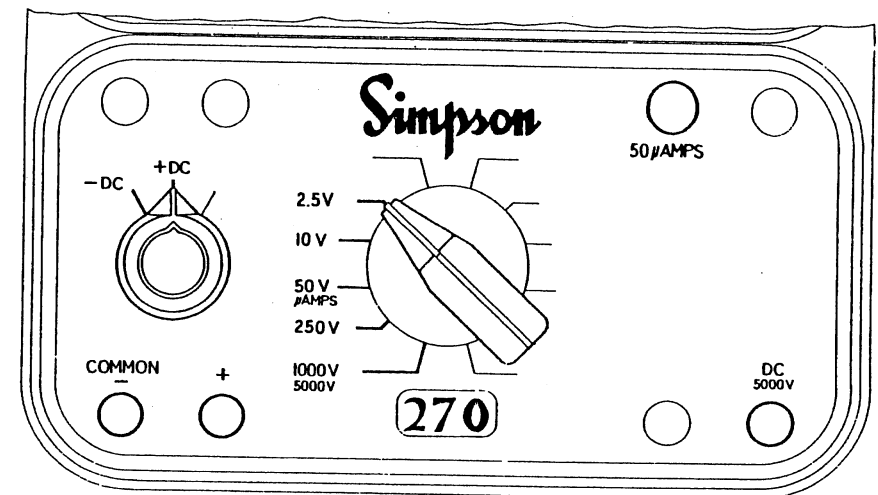

FIG. 2. JACKS AND SWITCH POSITIONS FOR D.C. VOLTS

### ADJUST POINTER FOR ZERO

Before any measurements are made, check to see that the pointer indicates zero when the meter is in its operating position. If the pointer is off zero, adjust the screw located in the phenolic case below the center of the meter scale, as shown in Figure 1. Use a small screwdriver to turn this screw slowly clockwise or counterclockwise until the pointer is exactly over the zero mark at the left side of the scale.

### D.C. VOLTAGE MEASUREMENTS, 0-250 MILLIVOLT RANGE ONLY

1. Set the function switch at +D.C.
2. Connect the black test lead in the COMMON – jack and the red test lead in the 50 $\mu$ AMPS jack.
3. Set the range switch at 50 $\mu$ AMPS (common position with 50 V.).
4. Connect the black test lead to the negative side of the circuit to be measured, and the red test lead to the positive side of the circuit.
5. Turn on power. If meter deflects to left of zero, turn off power and reverse the test lead connections. Then turn on power again.
6. Read the voltage on the black arc marked D.C., and use the figures marked 0 – 250; read directly in millivolts.
7. Turn off power in the circuit which is being measured before disconnecting meter leads.

### D.C. VOLTAGE MEASUREMENTS, 0-1000 VOLTS

1. Set the function switch on the left hand side of the front panel at +D.C.

2. Plug the black test lead into the COMMON – jack and the red test lead into the + jack.
3. Set the range selector switch in any of the five voltage range positions. These are marked 2.5 V., 10 V., 50 V., 250 V., and 1000 V. When in doubt as to the voltage present, always use the highest voltage range as a protection to the instrument. Observe the meter reading. If the voltage is within a lower range, the switch may be set for the lower range to obtain a more accurate reading.
4. Connect the black test lead to the negative side of the circuit to be measured and the red test lead to the positive side of the circuit.
5. Turn on the power in the circuit to be tested. If the pointer deflects to the left of zero, the anticipated polarity is opposite the actual circuit polarity. Turn off the power in the circuit which is being tested. Set the function switch at –D.C., and turn on the power again. This will correct the polarity as applied to the meter.
6. Read the voltage on the black arc marked D.C. which is second from the top of the dial.
  - For the 2.5 V. range, use the 0 – 250 figures and divide by 100.
  - For the 10 V., 50 V., and 250 V. ranges, read the figures directly on the scale.
  - For the 1000 V. range, use the 0 – 10 figures and multiply by 100.
7. Turn off the power in the circuit which is being measured before disconnecting meter leads.

## D.C. VOLTAGE MEASUREMENTS, 5000 VOLT RANGE

### WARNING

Be extremely careful when working in high voltage circuits. Do not touch the meter or test leads while power is on in the circuit being measured.

1. Set the function switch at +D.C.
2. Set the range selector switch at 5000 V.
3. Connect the black test lead into the COMMON - jack and the red test lead into the D.C. 5000 V. jack.
4. Be sure power is off in the circuit to be measured and all capacitors have been discharged; connect the black test lead to the negative side of the circuit to be measured and the red test lead to the positive side of the circuit.
5. Turn on the power in the circuit. Do not touch the meter or test leads. If the pointer deflects to the left side of zero, the anticipated polarity is opposite the actual circuit polarity. Turn off the power in the circuit being tested. Set the function switch at -D.C., and turn on the power again. This will correct the polarity as it is applied to the meter.
6. Read the voltage using the 0 - 50 figures on the black arc which is second from the top of the scale. Multiply the reading by 100.
7. Turn off the power before disconnecting the test leads.

NOTE: To measure higher D.C. Voltage, see section IV for high voltage accessory probes.

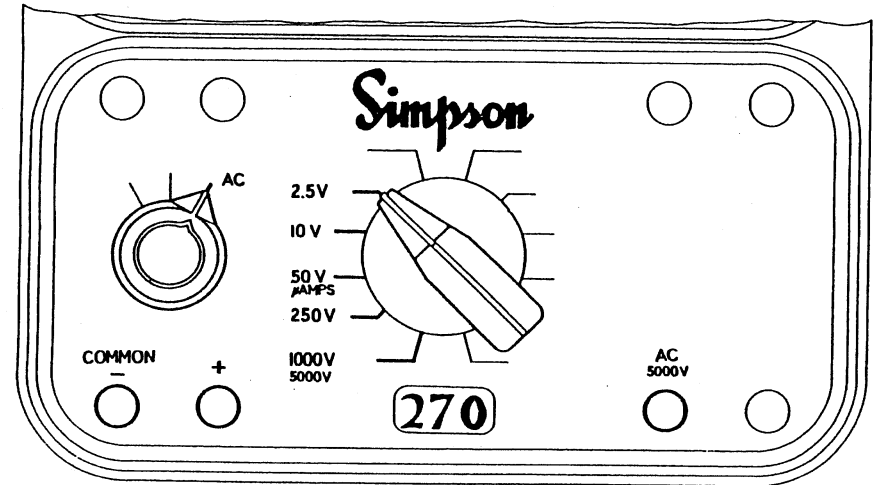

FIG. 3. JACKS AND SWITCH POSITIONS FOR A.C. VOLTS

## MEASURING A.C. VOLTAGES TO 1000 VOLTS

The 270 measures A.C. voltage in terms of the R.M.S. value of a sine wave. This is accomplished by using two germanium diodes in a modified full-wave bridge circuit.

1. Set the function switch at A.C.
2. Set the range selector switch in any of the five voltage range positions, marked 2.5 V., 10 V., 50 V., 250 V., and 1000 V. When in doubt as to the voltage present, always use the highest voltage range as a protection to the instrument. Observe the meter reading. If the voltage is within a lower range, the switch may be set for the lower range to obtain a more accurate reading.
3. Plug the black test lead into the COMMON - jack and the red test lead into the + jack.



## Operating Instructions

4. Be sure power is turned off in the circuit to be measured and connect the test leads across the voltage source.
5. Turn on the power in the circuit to be measured.
  - For the 0 – 2.5 V. range, read the value directly on the special arc marked 2.5 V.A.C. ONLY.
  - For the 10 V., 50 V., and 250 V. ranges, read the arc marked A.C., and use the red figures directly below the arc.
  - For the 1000 V. range, read the red arc marked A.C.; use the 0 – 10 figures and multiply by 100.

## MEASURING A.C. VOLTAGE TO 5000 VOLTS

### WARNING

Be extremely careful when working in high voltage circuits. Do not touch the meter or test leads while power is on in the circuit being measured.

1. Set the function switch at A.C.
2. Set the range selector switch at 5000 V.
3. Connect the black test lead into the COMMON – jack and the red test lead into the A.C. 5000 V. jack.
4. Be sure the power is off in the circuit to be measured and that all its capacitors have been discharged. Connect the test leads into the circuit.
5. Turn on the power in the circuit to be measured. Do not touch the meter or test leads.
6. Read the voltage on the red arc marked A.C.; use the 0 – 50 figures and multiply by 100.
7. Turn off the power before disconnecting the test leads.

## Operating Instructions

### MEASURING OUTPUT VOLTAGES

An output voltage is the A.C. component only, when there is a mixture of A.C. and D.C. voltages. This occurs mostly in amplifier circuits.

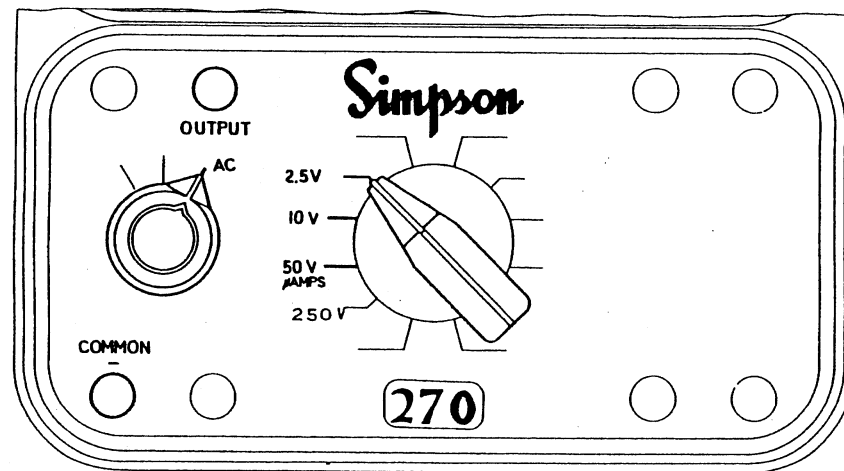

FIG. 4 JACKS AND SWITCH POSITIONS FOR OUTPUT

The tester has a capacitor in series with the OUTPUT jack. This blocks the D.C. component of the current in the measuring circuit, but allows the A.C., or desired component, to pass on to the meter circuit. The blocking capacitor placed in series with the A.C. voltage measuring circuits alters the low frequency A.C. response.

1. Set the function switch on the left hand side of the front panel at A.C.
2. Connect the black test lead in the COMMON – jack and the red test lead in the OUTPUT jack.

## Operating Instructions

3. Set the range selector switch at the desired range position. These are marked 2.5 V., 10 V., 50 V., and 250 V.
4. Connect the black test lead to the grounded side of the circuit to be measured, and the red test lead to the "hot" side.
5. Turn on the power in the circuit. Read the output voltage on the A.C. voltage arcs of the dial.

For the 2.5 V. range, read the value directly on the special arc marked 2.5 V.A.C. ONLY.

For the 10 V., 50 V., and 250 V. ranges, use the red arc marked A.C., and use the red figures directly below the arc.

6. Turn off the power in the circuit before disconnecting the leads.

### MEASURING DECIBELS

For some applications, output voltages and audio frequency voltages are frequently measured in terms of decibels. The decibel scale (DB), at the bottom of the dial, is numbered from -20 through 0 to +10.

To measure decibels, read the DB arc after proceeding according to instructions for A.C. voltage measurements.

The DB readings obtained will be correct on an absolute scale if you are using a 0 DB power level of 0.001 watt in 600 ohms, and if the voltage which you read was measured across 600 ohms.

## Operating Instructions

To obtain absolute DB values across 600 ohms:

For the 10 V. range, read the DB arc and add +12 DB to the reading.

For the 50 V. range, read the DB arc and add +26 DB to the reading.

For the 250 V. range, read the DB arc and add +40 DB to the reading.

If the reference level is 0 DB = 0.006 watt in 500 ohms, subtract (+)7 DB from the reading to obtain the absolute value of decibels.

### OHMMETER CIRCUIT

Internal batteries are used to provide power for resistance measurements. Since the batteries are subject to deterioration over long periods of time, there is a compensating circuit in the ohmmeter to make it possible to extend the useful life of the batteries.

### ZERO OHMS ADJUST

Each time you use the ohmmeter circuit, check the zero indication on the meter before you measure any resistance. Check and adjust it each time you switch to a different range. To set the ZERO OHMS control, proceed as follows:

1. Set the range switch at one of the resistance range positions and the function switch at either -D.C. or +D.C.
2. Connect the black test lead in the COMMON - jack and the red test lead in the + jack.
3. Clip the contact end of the test leads together to short out the resistance circuit.

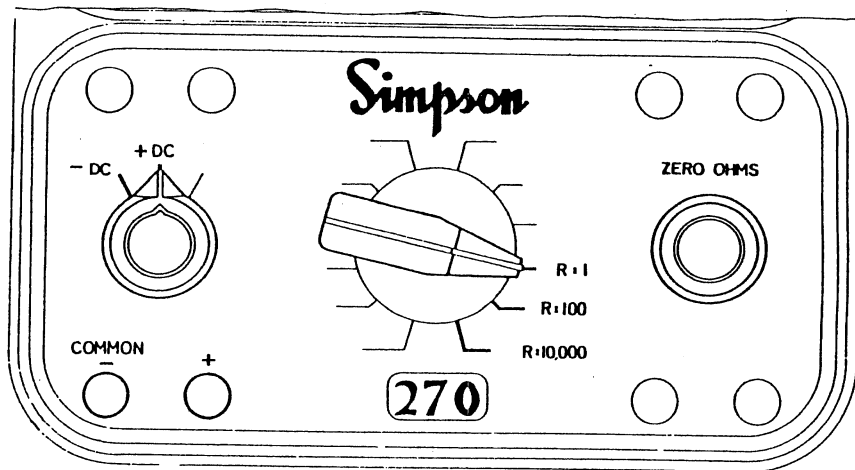

FIG. 5 JACKS AND SWITCH POSITIONS FOR RESISTANCES

4. Observe the meter indication. It should read 0 on the right hand end of the OHMS arc, which is at the top of the dial.
5. If the pointer does not read 0, rotate the ZERO OHMS knob until it does. If you cannot bring the pointer far enough to read 0, one or more batteries need to be replaced.
6. When the pointer shows zero, unclip the shorted test leads; the ohmmeter circuit is now ready to measure resistance.

### MEASURING RESISTANCES

To measure resistance, proceed as follows:

1. Set the range switch in one of the resistance range positions.

Use R x 1 for resistance readings from 0 to 200 ohms.  
Use R x 100 for resistance readings from 200 up to 20,000 ohms.

Use R x 10,000 for resistance readings above 20,000 ohms.

2. Set the function switch at either -D.C. or +D.C.
3. Connect the black test lead in the COMMON - jack and the red test lead in the + jack.
4. Short the test leads together and adjust for zero ohms (see instructions above).
5. Separate the test leads and connect them across the resistance which is to be measured. If there is a "forward" and "backward" resistance such as in semiconductor rectifiers, switch back and forth between the two D.C. positions of the function switch to reverse this polarity.

### NOTE

The resistance of such rectifiers will measure different values on different resistance ranges. A crystal diode which measures 80 ohms on the R x 1 range may measure 300 ohms on the R x 100 range. This is normal and is a result of the diode characteristic. The difference in values does not indicate any fault in the ohmmeter.

6. Read the indication on the OHMS arc at the top of the dial. Note that this arc reads from right to left for increasing values.
7. Multiply the reading by the multiplier factor at the switch position for the resistance value in ohms. "K" on the dial stands for "thousand".

## Operating Instructions

- Resistance measurements in transistor circuits should be made only after the transistor has been isolated from the circuit.

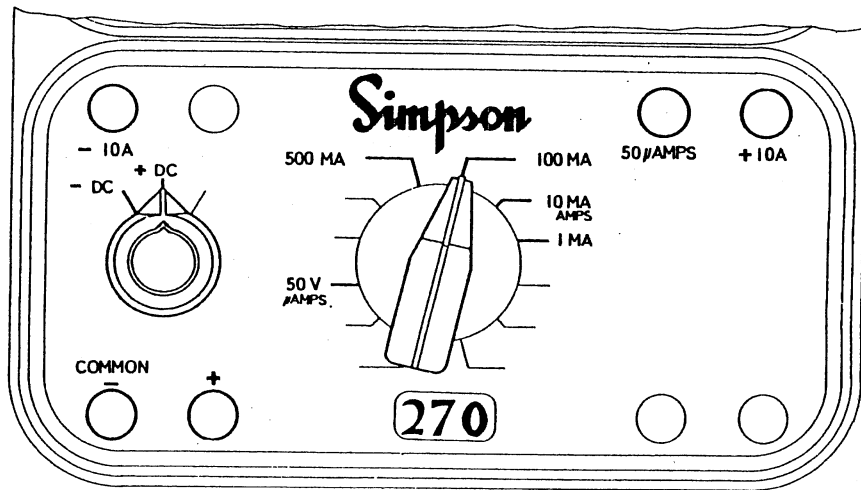

FIG. 6 JACKS AND SWITCH POSITIONS FOR DIRECT CURRENTS

### MEASURING DIRECT CURRENTS, 0 TO 50 MICROAMPERES

#### CAUTION

Never connect the test leads directly across any voltage when the 270 is used as a current meter, except when it is used as a 0–250 millivoltmeter. This would damage the instrument. Always connect the meter in series with the load across the voltage source.

- Set the function switch at +D.C.
- Connect the black test lead in the COMMON – jack and the red test lead in the 50μAMPS jack.

## Operating Instructions

- Set the range switch at 50μAMPS (common position with 50 V.).
- Open the circuit in which the current is to be measured. Connect the meter in series with the circuit. Connect the red test lead toward the positive side, and the black test lead toward the negative side of the circuit.
- Turn on the power in the circuit which is to be measured. Observe the meter. If the pointer is deflected to the left, the current polarity is opposite to that which was anticipated. Turn off the power and reverse leads.
- Read the current directly on the black D.C. arc. Use the 0 – 50 figures. The current value is shown in microamperes.
- Turn off the circuit power. Remove the test leads and restore the circuit continuity.

### MEASURING DIRECT CURRENTS, 0 to 500 MILLIAMPERES

- Set the function switch at +D.C.
- Connect the black test lead in the COMMON – jack and the red test lead in the + jack.
- Set the range switch in any of the four range positions required. These are marked 1 MA., 10 MA., 100 MA., and 500 MA.
- Open the circuit which is to be measured. Connect the meter in series with the circuit. Connect the red test lead toward the positive side and the black test lead toward the negative side of the circuit.
- Turn on the power in the circuit which is to be measured. Observe the meter. If the pointer is deflected to

## Operating Instructions

the left, the current polarity is opposite to that which was anticipated. Turn off the power, set the function switch at -D.C., and then turn on the power again.

6. Read the current directly on the black D.C. arc.  
For the 1 MA range use the 0 - 10 figures and divide by 10.  
For the 10 MA range use the 0 - 10 figures directly.  
For the 100 MA. range read the 0 - 10 figures and multiply by 10.  
For the 500 MA. range read the 0 - 50 figures and multiply by 10.  
The current values are in milliamperes.
7. Turn off the circuit power. Remove the test leads and restore circuit continuity.

### MEASURING DIRECT CURRENTS, 0 TO 10 AMPERES

1. Connect the black test lead in the - 10 A. jack and the red test lead in the +10 A. jack.
2. Set the range selector switch at 10 AMPS (common with 10 MA.).
3. Open the circuit which is to be measured. Connect the meter in series with the circuit. Connect the red test lead toward the positive side and the black test lead toward the negative side of the circuit.
4. Turn on the power in the circuit which is to be measured. Observe the meter. If the pointer is deflected to the left, the current polarity is opposite to that which was anticipated. Turn off the power, reverse the test lead connections, and turn on the power again.

## Maintenance

5. Read the current directly on the black D.C. arc. Use the 0 - 10 figures. The current values are in amperes.
6. Turn off the circuit power. Remove the test leads and restore circuit continuity.

### SECTION III MAINTENANCE

#### HOW TO OPEN THE CASE

To open the case, use a 1/4-inch screwdriver to remove the four screws through the bottom of the case. Then slip the entire front panel forward out of the case. The meter, the front panel, the printed circuit, and the batteries are all attached together and will come out as a unit.

#### BATTERY REPLACEMENT

There are five batteries inside the case behind the front panel. They are used to supply power for resistance measurements. One is a large size (#2, Size D) flashlight cell, and the other four are smaller (#Z) flashlight cells.

When it is no longer possible to bring the pointer to 0 for the R x 1 and R x 100 ranges (see ZERO OHMS ADJUST, page 19), replace the large cell with a fresh one. When it is no longer possible to bring the pointer to 0 on the R x 10,000 range, replace the four smaller cells with fresh ones. This will restore operation of the ohmmeter circuit.

#### BATTERY REPLACEMENT NOTE

When batteries reach the end of their useful life, they

should be replaced promptly. Failure to do so may result in extensive damage to your tester, due to battery leakage, even though the battery may be labeled "Leakproof".

### OBSERVE POLARITY

When cells are replaced, be sure to observe the polarity of the battery circuit. The cells are each held in place with specially designed spring clips which also act as battery contacts. Battery polarity is shown on the panel.

### RECTIFIER REPLACEMENT AND RECALIBRATION

There are two small rectifiers which are located at the top of the printed circuit, near the large 1.5 volt cell. These are used to rectify the A.C. voltages for measurement. They are shown as D-1 and D-2 in the overall schematic diagram, Fig. 7.

Both rectifiers act in the meter circuit to effectively create a full wave rectifying action. If either or both should fail, the meter will show incorrect indications.

In case of rectifier failure, order a new rectifier from a Simpson Parts Depot (pages 35-38), specifying the part number as shown in the parts list. In order to maintain the accuracy of the 270, it is essential to replace rectifiers with the type furnished in the original unit.

After replacing either or both rectifiers, test the accuracy of A.C. voltage indications. If necessary, recalibrate the circuit by adjusting rheostats R-28 and R-31 as follows:

1. Set the function switch at A.C. and the range switch at 250 V.
2. Connect the red test lead in the + jack and the black test lead in the COMMON - jack.
3. From a standard voltage source, apply 250 volts A.C. to the red and black test lead. Adjust rheostat R-31 (located at the upper right hand corner of the printed circuit board, viewed from rear of instrument) so the meter reads full scale. Turn power off.
4. Set the range switch to 2.5 V. Apply 2.5 volts A.C. to the red and black test leads. Adjust rheostat R-28 (located at the upper left hand portion of the printed circuit board), so the meter reads full scale. Turn power off.

If no standard voltage supply is available for the above procedure, return your 270 to the Simpson Electric Company or an Authorized Warranty Repair Station for calibration.

### RESISTOR REPLACEMENT

Most of the resistors for the 270 are on the rear of the printed circuit. This makes them easily accessible for trouble-shooting and repair.

When it is necessary to replace any of the resistors in the circuit, first obtain an exact equivalent resistor. The best way to do this is to order the resistor or resistors directly from a Simpson Parts Depot (pages 35-38) specifying the part number as shown in the parts list. Then clip the defective resistor off the printed circuit board, leaving the leads in the board to use as connections for the replacement.

Carefully twist the leads for the new resistor around the leads left from the defective resistor, and solder each connection. Trim away all excess and check that no shorts have developed due to the substitution.

### REMOVING THE PRINTED CIRCUIT

When access is required to the under-side of the printed circuit, or to the parts which are located between it and the front panel, remove the printed circuit.

Use the following procedure:

1. Set the function switch at +D.C. and the range switch at 2.5 V.
2. Remove the knob for the ZERO OHMS control.
3. Remove the two screws through the lower part of the printed circuit board.
4. Remove the two hex nuts from the meter studs on the top of the printed circuit board.
5. Carefully pry out the battery contact at the + terminal for the small 1.5 volt cells, and the - terminal for the large 1.5 volt cell.
6. Lift the printed circuit board away from the front panel. The entire board, with the switch wafers in place, will come up in one piece.
7. After removal, do not turn knobs on front panel or move any rotors on switches until reassembled.

### FUSE REPLACEMENT

Remove the front panel from the case and disconnect the burned-out fuse, using a small (60-watt or less) soldering iron. Replace with a 1 amp, 250 volt pigtail fuse, type 3AG or equivalent only.

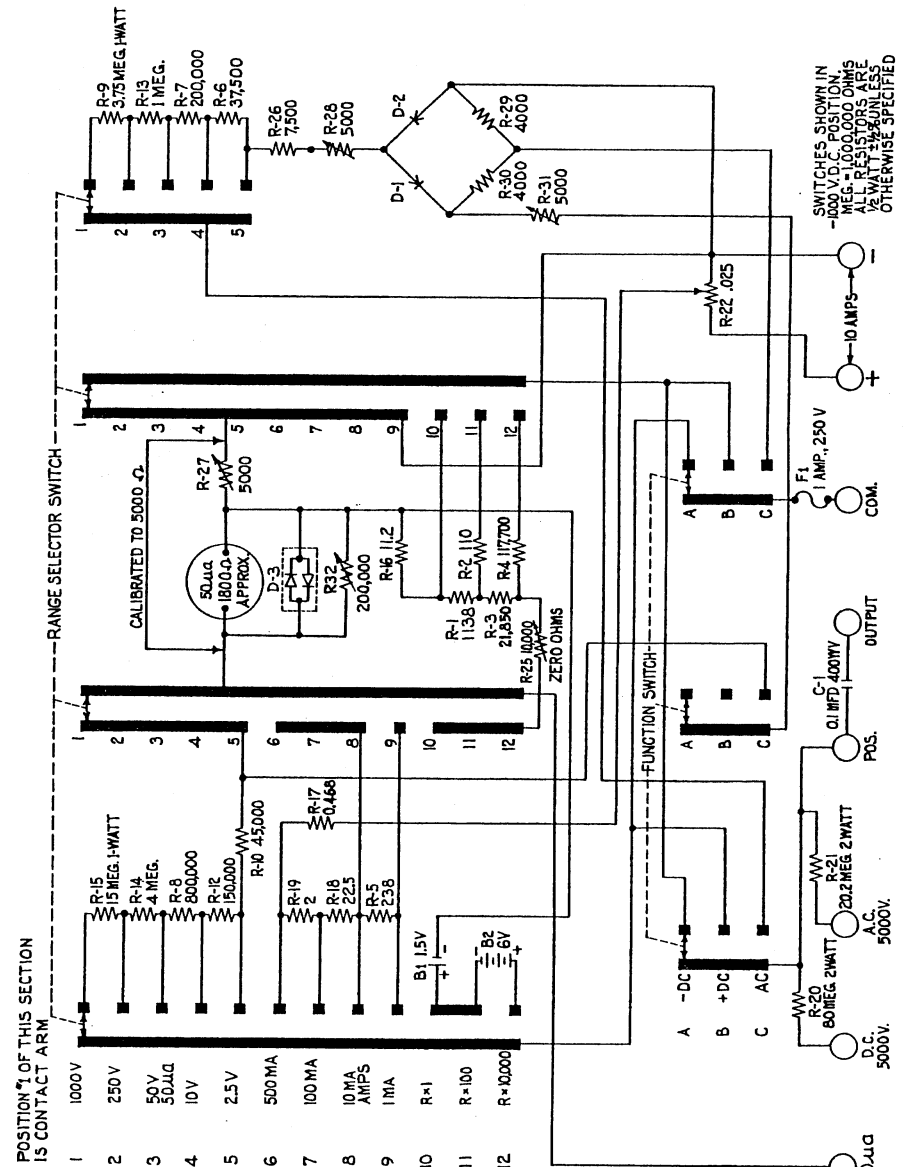

FIGURE 7. OVERALL SCHEMATIC, SIMPSON VOLT-OHM-MILLIAMMETER, 270 SERIES 3.

## Maintenance

## PARTS LIST

Reference Symbol	Description	Simpson Part No.
R1	Resistor, 1138 ohms (all resistors $\pm 1/2\%$ )	1-117141
R2	Resistor, 110 ohms	1-117142
R3	Resistor, 21,850 ohms	1-117143
R4	Resistor, 117,700 ohms	1-117144
R5	Resistor, 238 ohms (bobbin)	10-805075
R6	Resistor, 37,500 ohms	1-117145
R7	Resistor, 200,000 ohms	1-117146
R8	Resistor, 800,000 ohms	1-117147
R9	Resistor, 3.75 megohms	1-117135
R10	Resistor, 45,000 ohms	1-117148
R12	Resistor, 150,000 ohms	1-117149
R13	Resistor, 1 megohm	1-117150
R14	Resistor, 4 megohms	1-117151
R15	Resistor, 15 megohms	1-117136
R16	Resistor, 11.2 ohms (bobbin)	10-805073
R17	Resistor, 0.468 ohm (bobbin)	10-675254
R18	Resistor, 22.5 ohms (bobbin)	10-805076
R19	Resistor, 2 ohms (bobbin)	10-805077
R20	Resistor, 80 megohms	11-117138
R21	Resistor, 20.2 megohms	1-117137
R22	Resistor, 0.025 Shunt Assy., 10 amp	0-007093
R25	Potentiometer, 10,000 ohms $\pm 30\%$	5-110295
R26	Resistor, 7500 ohms	1-117152
R27	Rheostat, 5000 ohms $\pm 10\%$	1-116254
R28	Rheostat, 5000 ohms $\pm 10\%$	1-116254

## Maintenance

## Reference Symbol

## Description

## Simpson Part No.

R29	Resistor, 4000 ohms	1-117140
R30	Resistor, 4000 ohms	1-117140
R31	Rheostat, 5000 ohms $\pm 10\%$	1-116254
R32	Potentiometer 200K $\pm 20\%$	1-110193
C1	Capacitor, 0.1 $\mu$ f, 400 v.	1-113733
D1	Rectifier, Germanium	1-110722
D2	Rectifier, Germanium	1-110722
D3	Varistor, Silicon	1-110670
	Test lead set (one red and one black)	7500
	Phenolic case (less handle)	3-320141
	Carrying handle plastic cover	1-115316
	Knobs:	
	For Function switch	1-115789
	For Range switch (less set screw)	3-260180
	Set Screw (for knob 3-260180)	1-114178
	For Zero Ohms Adjust	1-115790
F1	Fuse, 1 amp, 250 volt, pigtail type 3AG or equivalent	1-117702
	Cover Assembly	0-005674
	(This includes cover glass glazed into phenolic frame and associated hardware.	
	NOTE - Standard glazing compounds can not be used for re-glazing.)	
	Cell, 1 1/2 V., #2, Size D	1-111798
	Cell, 1 1/2 V., Size Z (4 req.)	1-111802
	Meter Assembly	15-302270-3
	(This includes engraved panel, meter, dial, mirror, and cover assembly.)	



Reference Symbol	Applications Description	Simpson Part No.
	Carrying handle insert (aluminum handle without plastic covering.)	3-810427

## SECTION IV APPLICATIONS

### SIMPLE CAPACITOR CHECKS

The ohmmeter circuit can be used to identify good, open, and short conditions for many capacitors. Use the R x 10,000 range for best results.

A good capacitor will allow current to flow, deflecting the meter pointer, while it is charging up to the applied voltage. This produces a swing on the meter, with a gradual return of the pointer to infinity at the left hand side of the scale. The greater the capacity, the more the pointer will swing and the longer it will take for it to return to infinity.

If the capacitor is open, there will be no pointer deflection at the beginning of this test. Note that very small capacitors will have only a very slight deflection and a rapid return to infinity. Watch the meter closely when you test small capacitors.

If the capacitor is shorted, the pointer will not return to infinity. So when the pointer remains deflected on the ohms

## Applications

scale, and does not return, even slowly, this probably indicates a short in the capacitor.

Always reconfirm the results of these simple tests with more conclusive test equipment, or by replacement checks.

### CAUTION

**DISCHARGE CAPACITOR** completely before connecting ohmmeter.

The Volt-Ohm-Milliammeter, commonly called the Multimeter, has developed into one of the most valuable instruments in all electrical and electronic fields. The applications of the Multimeter are so numerous and varied that, without exception, they can be said to cover the entire field of electrical measurements.

Your 270 Multimeter has been carefully engineered to produce the most accurate, dependable and rugged instrument consistent with modern design techniques for the many applications in which it will be used. In view of the practically unlimited number of applications, it is suggested that text books be referred to regarding this subject in order to fully utilize the versatility of this instrument.

### ACCESSORY DC HIGH VOLTAGE PROBES

**DC HIGH VOLTAGE TEST PROBES**  
(20,000 OHMS PER VOLT)

**PART NO. 0507**

**10,000-Volts DC**

## Applications

PART NO. 0508

25,000 Volts DC

PART NO. 0509

50,000 Volts DC

### GENERAL DESCRIPTION

The DC high voltage probes extend the range of a 20,000 ohms per volt multimeter in a safe, convenient manner at nominal cost. Their primary purpose is the measurement of terminal potentials of very high voltage, very low power capacity, direct current sources, example of which are anode supplies used in television receivers and other cathode ray tube type circuitry.

The probe body is made of high temperature polystyrene in order to provide high dielectric strength and low leakage. It contains a high megohm precision resistor.

A shielded cable and internal probe shield is used to protect the operator from any possible flash-over and to ground any electrostatic charges that might accumulate on the probe body.

The internal shield and cable shield are connected to the ground return lead by a flexible copper braid between the two elbow connectors. A 48 inch ground return lead with an insulated clip completes the test lead set. No additional wires are needed.

The DC high voltage test probes are available at your local electronics parts distributor.

### SIMPSON WARRANTY REPAIR STATIONS AND PARTS DEPOTS

Alabama, Huntsville 35805 Electro Tech, Inc. 106 Jordan Lane N.W.	Area Code 205 539-1250
Arizona, Phoenix 85034 Kierulff (Metermaster) 2633 E. Buckeye	Area Code 602 273-7331
California, Glendale 91201 JSD Engineering Company 6915 San Fernando Road	Area Code 213 840-6187
California, Los Angeles 90022 Metermaster/Los Angeles 5646 Jellson St.	Area Code 213 686-4340
California, Palo Alto 94303 Kierulff/Metermaster 3969 E. Bayshore Road	Area Code 415 968-6292
California, San Diego 92111 Metermaster/Kierulff 8796 Balboa Ave.	Area Code 714 278-2112
California, San Francisco 94105 Pacific Electrical Instrument Lab. 111 Main Street	Area Code 415 421-7185
Colorado, Denver 80209 Meter Master Instrument Service 748 South Broadway	Area Code 303 722-5766
Connecticut, Middletown The Mancb Co. Randolph Road and Coe	Area Code 203 347-5629
Connecticut, New Haven 06511 Kaufman Instrument Lab. 810 Dixwell Avenue	Area Code 203 776-7201
Florida, Miami 33136 Florida Precision Instrument Corp. 800 N.W. 7th Avenue	Area Code 305 374-1731
Florida, Orlando 32806 Electro Tech, Inc. 307 - 27th Street	Area Code 305 423-5589